

1-1 DATA COMMUNICATIONS

*The term **telecommunication** means communication at a distance. The word **data** refers to information presented in whatever form is agreed upon by the parties creating and using the data. **Data communications** are the exchange of data between two devices via some form of transmission medium such as a wire cable.*

Topics discussed in this section:

Components

Data Representation

Data Flow

Figure 1.1 *Five components of data communication*

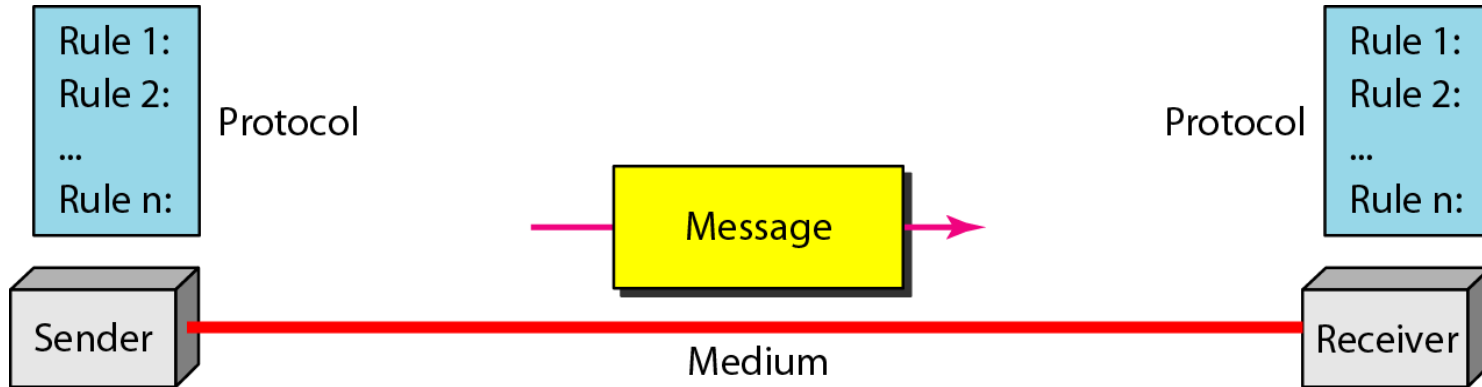
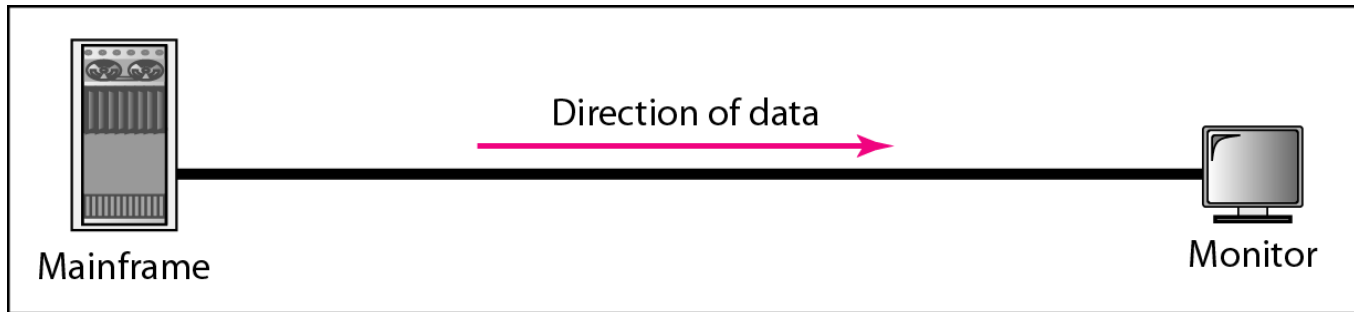
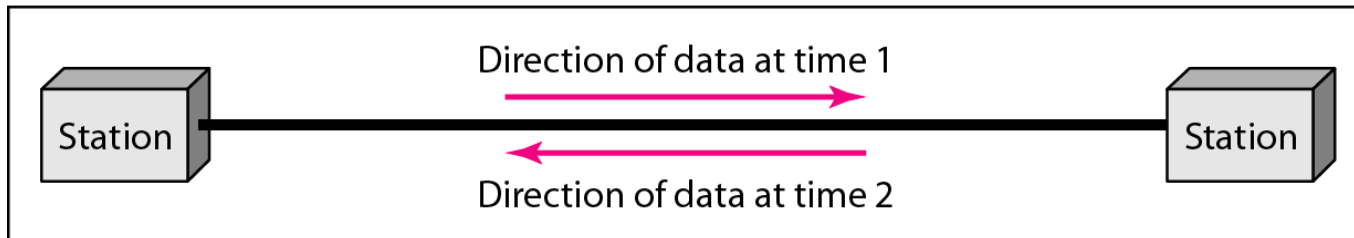

Figure 1.2 *Data flow (simplex, half-duplex, and full-duplex)*



a. Simplex



b. Half-duplex

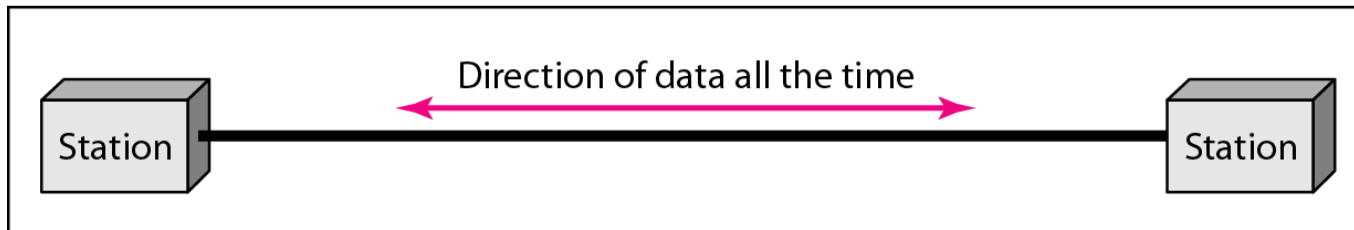

c. Full-duplex

1-2 NETWORKS

*A **network** is a set of devices (often referred to as **nodes**) connected by communication **links**. A node can be a computer, printer, or any other device capable of sending and/or receiving data generated by other nodes on the network.*

Topics discussed in this section:

Distributed Processing

Network Criteria

Physical Structures

Network Models

Categories of Networks

Interconnection of Networks: Internetwork

Figure 1.3 *Types of connections: point-to-point and multipoint*

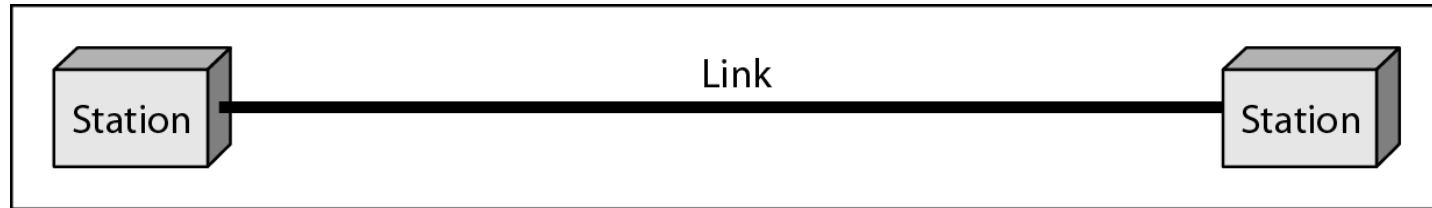

a. Point-to-point

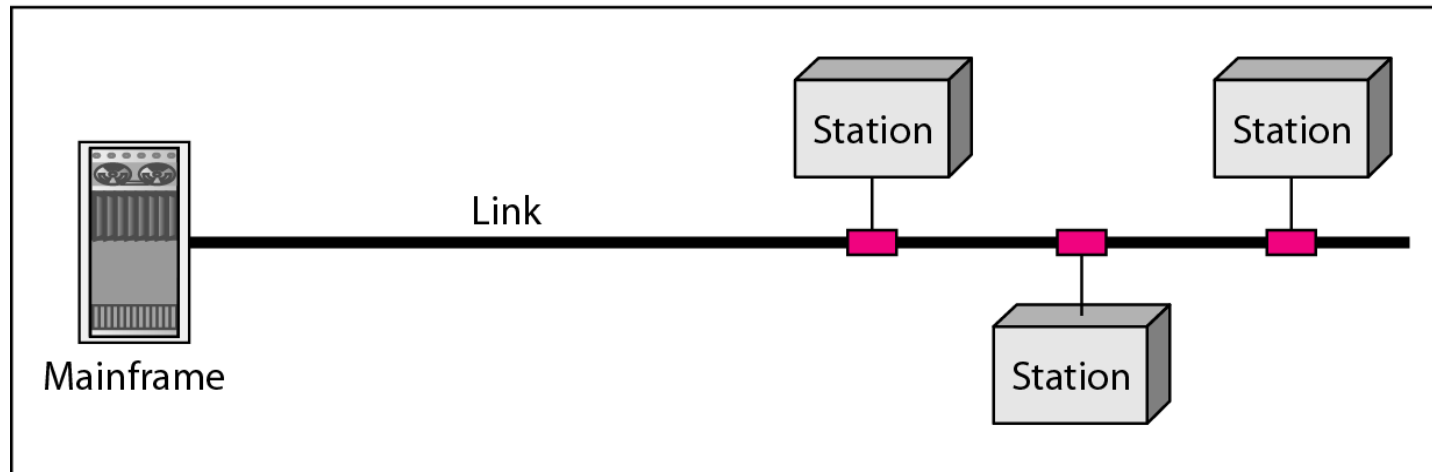

b. Multipoint

Figure 1.4 *Categories of topology*

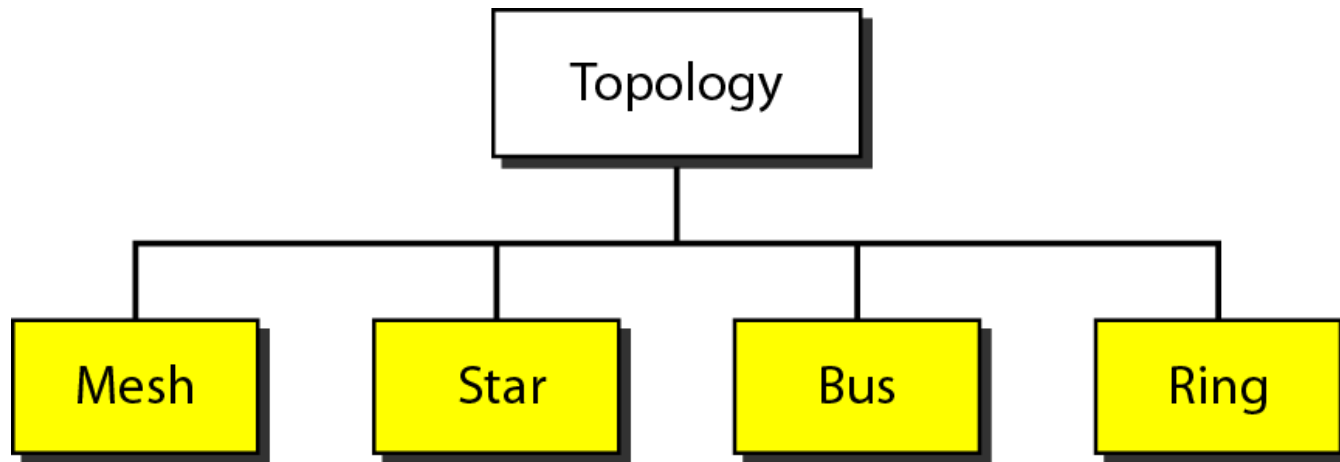

Figure 1.5 *A fully connected mesh topology (five devices)*

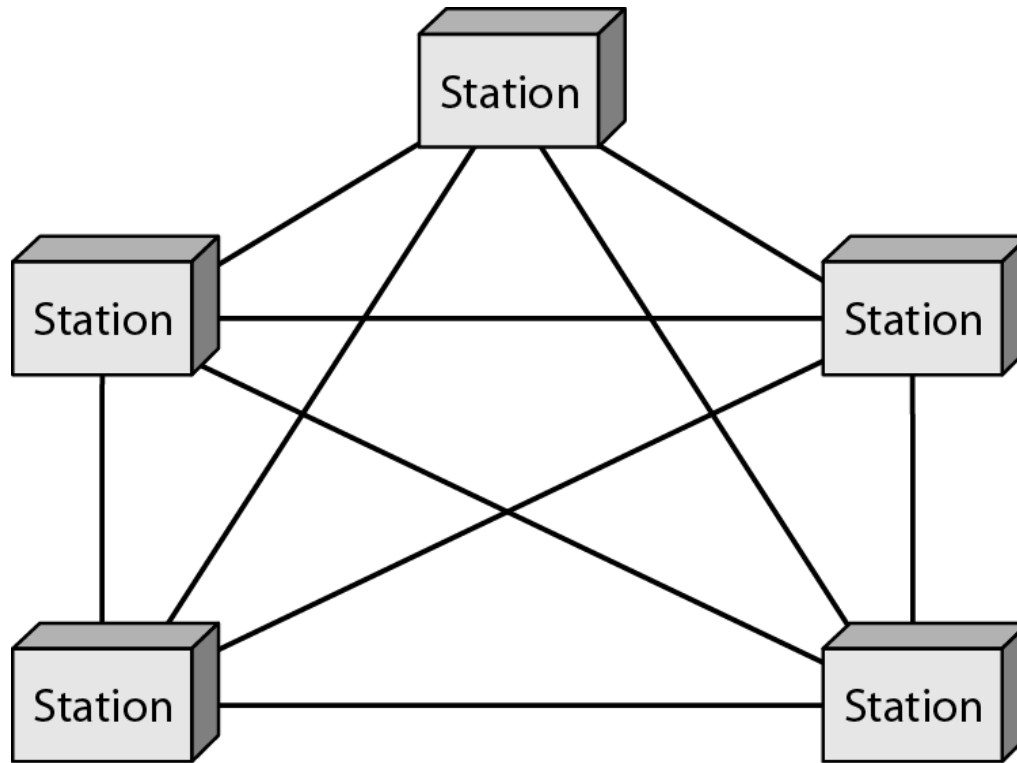

Figure 1.6 *A star topology connecting four stations*

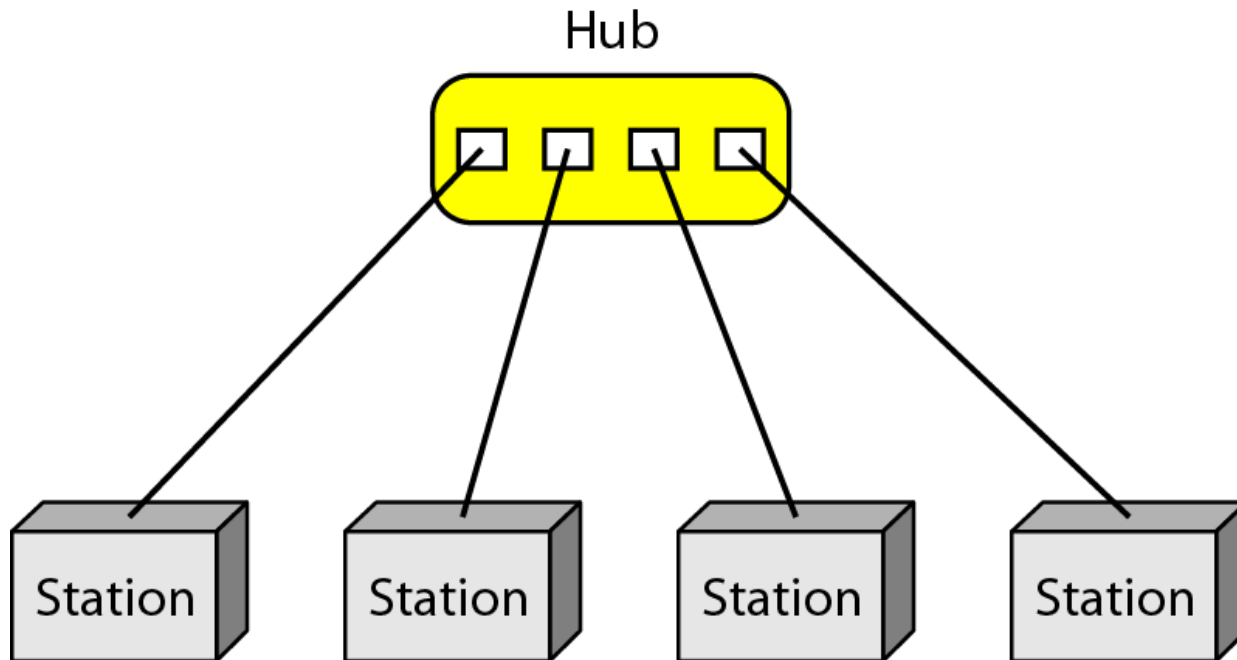

Figure 1.7 *A bus topology connecting three stations*

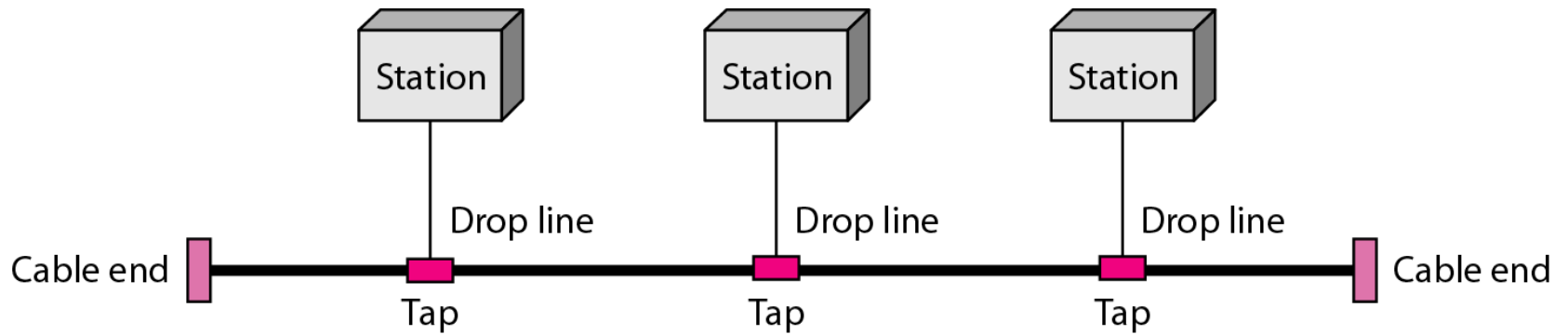

Figure 1.8 *A ring topology connecting six stations*

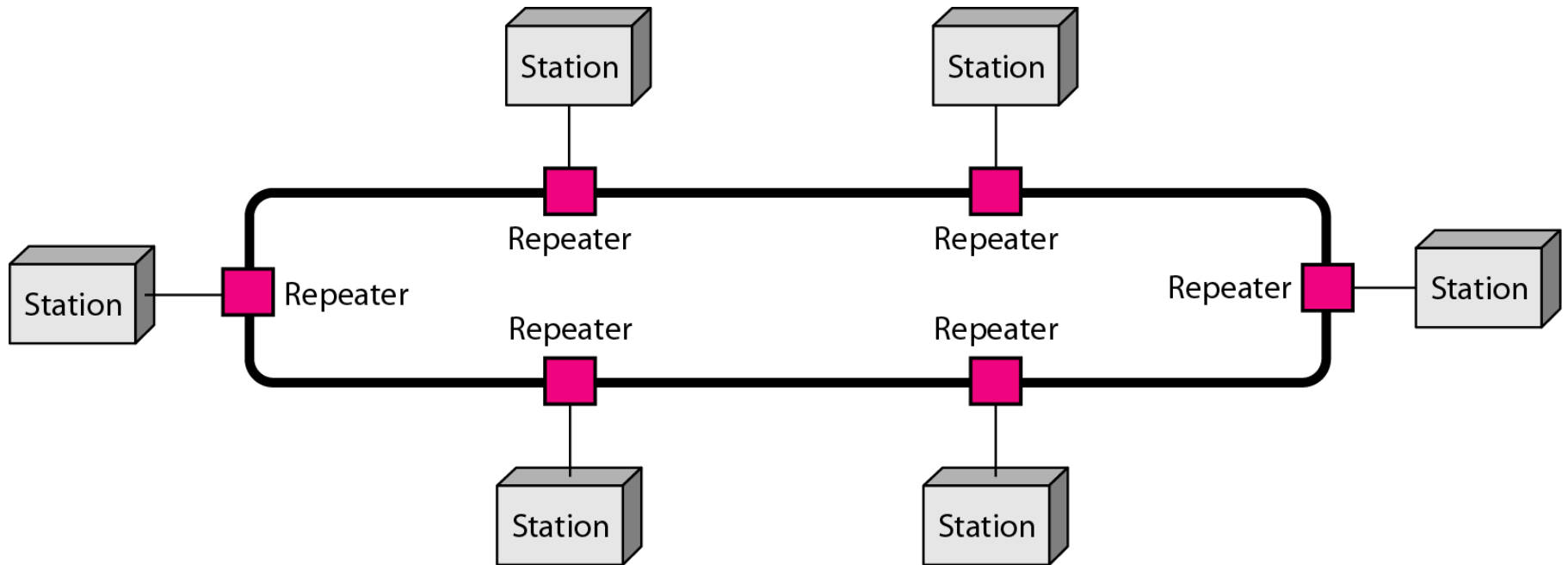

Figure 1.9 *A hybrid topology: a star backbone with three bus networks*

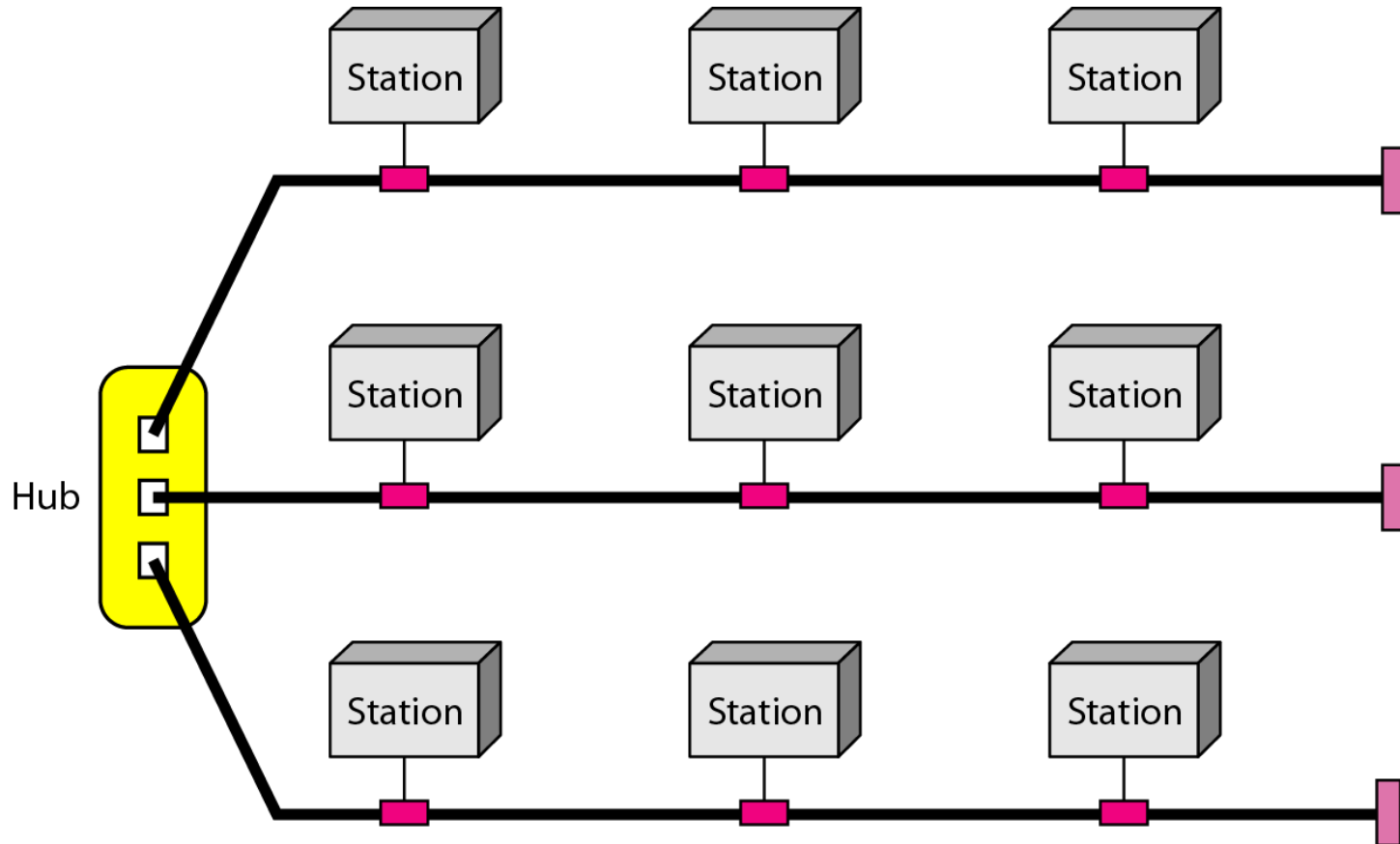

Figure 1.10 *An isolated LAN connecting 12 computers to a hub in a closet*

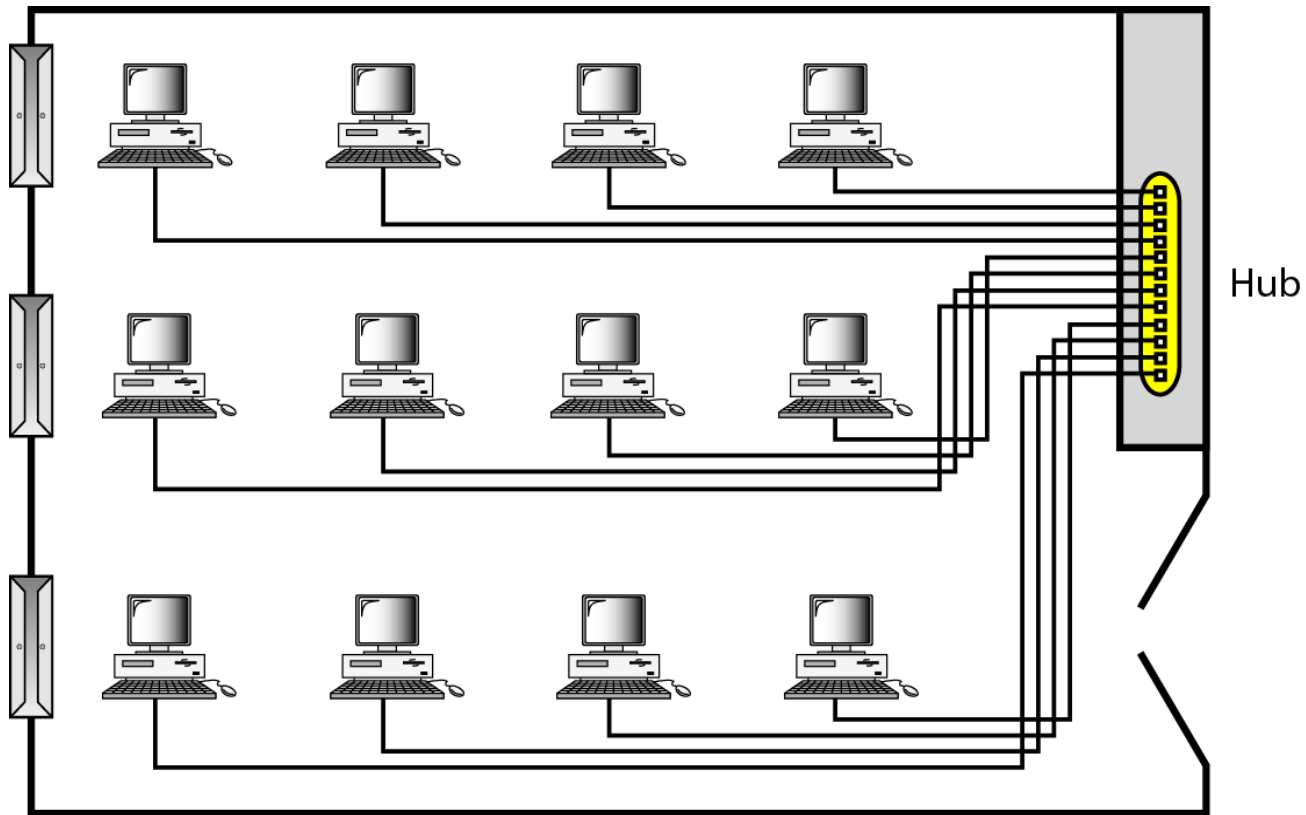
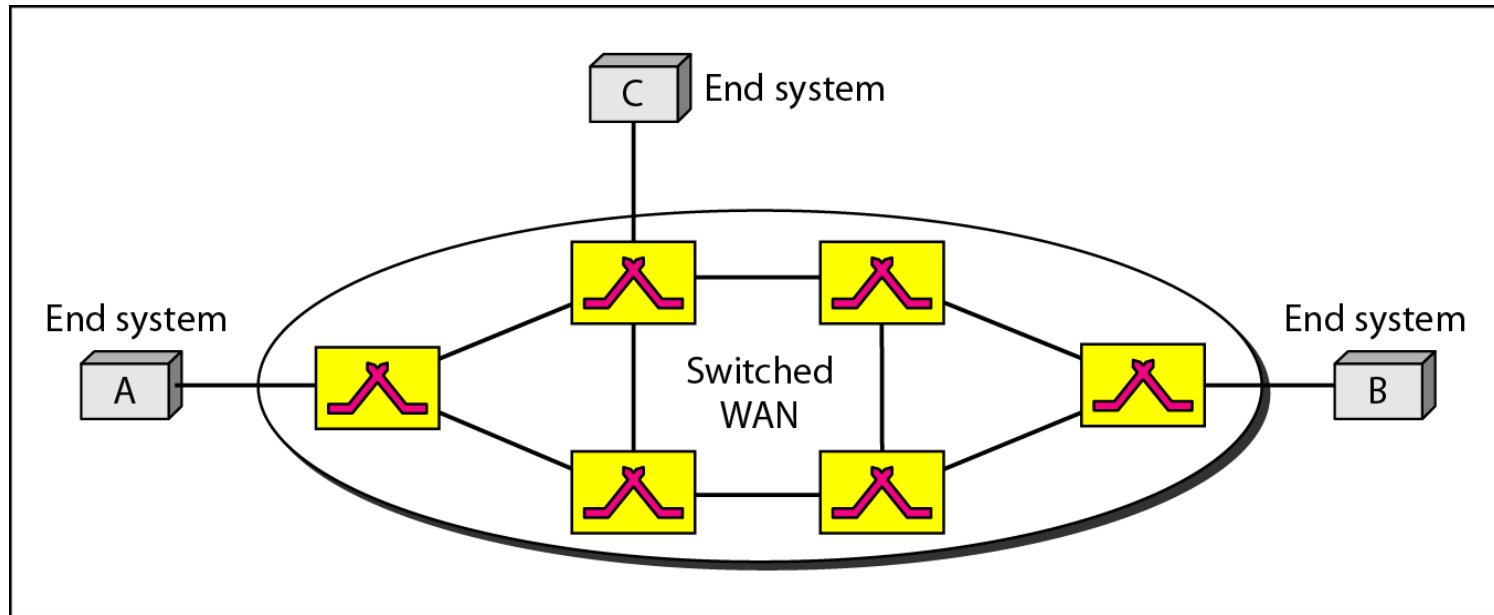
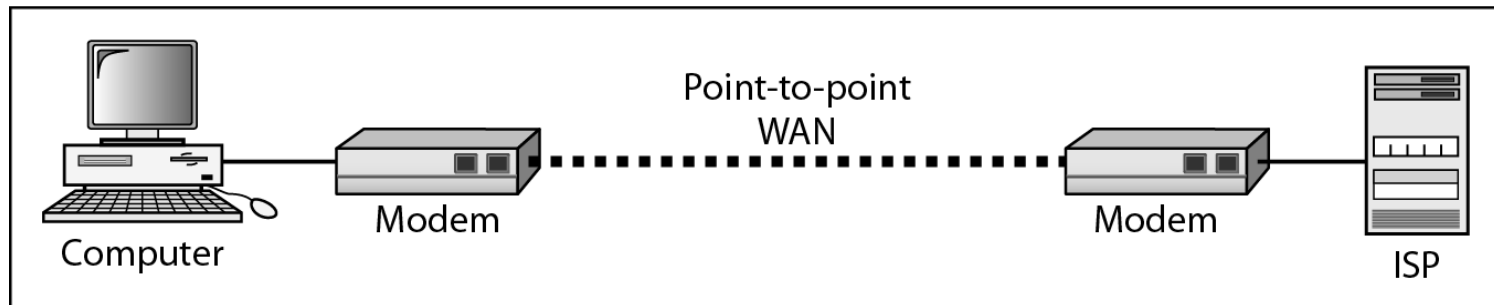

Figure 1.11 *WANs: a switched WAN and a point-to-point WAN*



a. Switched WAN



b. Point-to-point WAN

Figure 1.12 *A heterogeneous network made of four WANs and two LANs*

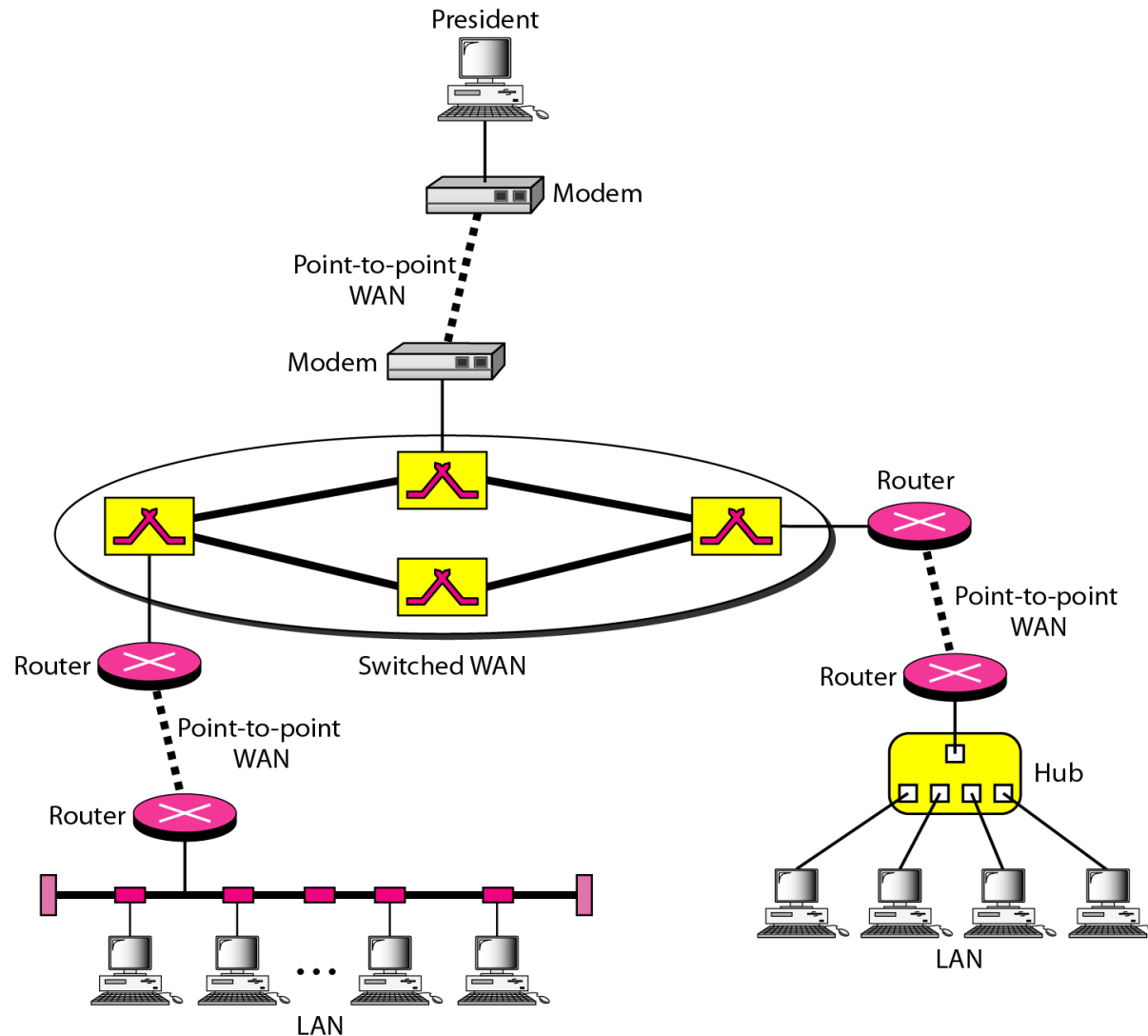

1-3 THE INTERNET

*The **Internet** has revolutionized many aspects of our daily lives. It has affected the way we do business as well as the way we spend our leisure time. The Internet is a communication system that has brought a wealth of information to our fingertips and organized it for our use.*

Topics discussed in this section:

A Brief History

The Internet Today (ISPs)

Figure 1.13 *Hierarchical organization of the Internet*

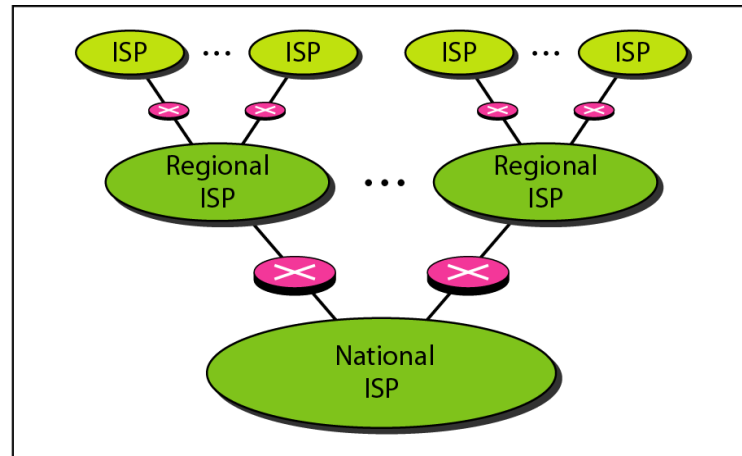

a. Structure of a national ISP

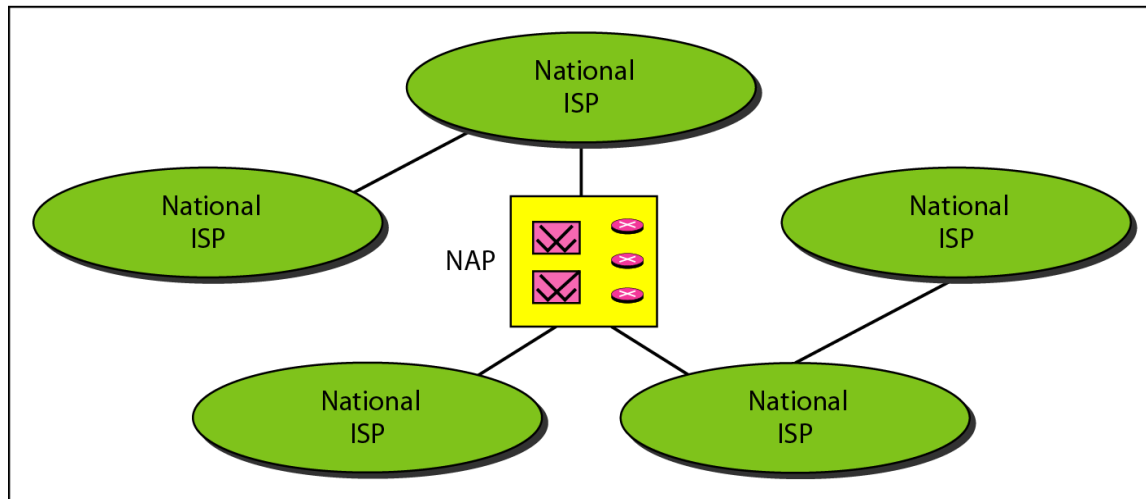

b. Interconnection of national ISPs

1-4 PROTOCOLS AND STANDARDS

*In this section, we define two widely used terms: **protocols** and **standards**. First, we define protocol, which is synonymous with rule. Then we discuss standards, which are agreed-upon rules.*

Topics discussed in this section:

Protocols

Standards

Standards Organizations

Internet Standards